

RangeMax NEXT Wireless-N Access Point WN802T Reference Manual



NETGEAR®

NETGEAR, Inc.
4500 Great America Parkway
Santa Clara, CA 95054 USA

202-10204-03
v1.0
August 2007

Trademarks

NETGEAR, the NETGEAR logo, RangeMax and Auto Uplink are trademarks or registered trademarks of NETGEAR, Inc. Microsoft, Windows, and Windows NT are registered trademarks of Microsoft Corporation.

Other brand and product names are registered trademarks or trademarks of their respective holders. Portions of this document are copyright Intoto, Inc.

Statement of Conditions

In the interest of improving internal design, operational function, and/or reliability, NETGEAR reserves the right to make changes to the products described in this document without notice.

NETGEAR does not assume any liability that may occur due to the use or application of the product(s) or circuit layout(s) described herein.

Regulatory Compliance Information

This section includes user requirements for operating this product in accordance with National laws for usage of radio spectrum and operation of radio devices. Failure of the end-user to comply with the applicable requirements may result in unlawful operation and adverse action against the end-user by the applicable National regulatory authority.

NOTE: This product's firmware limits operation to only the channels allowed in a particular Region or Country. Therefore, all options described in this user's guide may not be available in your version of the product.

Europe – EU Declaration of Conformity



Marking by the above symbol indicates compliance with the Essential Requirements of the R&TTE Directive of the European Union (1999/5/EC). This equipment meets the following conformance standards:

EN300 328, EN301 489-17, EN60950

Europe – Declaration of Conformity in Languages of the European Community

Cesky [Czech]	<i>NETGEAR Inc.</i> tímto prohlašuje, že tento Radiolan je ve shode se základními požadavky a dalšími příslušnými ustanoveními směrnice 1999/5/ES..
Dansk [Danish]	Undertegnede <i>NETGEAR Inc.</i> erklærer herved, at følgende udstyr Radiolan overholder de væsentlige krav og øvrige relevante krav i direktiv 1999/5/EF.
Deutsch [German]	Hiermit erkläre <i>NETGEAR Inc.</i> , dass sich das Gerät Radiolan in Übereinstimmung mit den grundlegenden Anforderungen und den übrigen einschlägigen Bestimmungen der Richtlinie 1999/5/EG befindet.
Eesti [Estonian]	Käesolevaga kinnitab <i>NETGEAR Inc.</i> seadme Radiolan vastavust direktiivi 1999/5/EÜ põhinõuetele ja nimetatud direktiivist tulenevatele teistele asjakohastele sätetele.
English	Hereby, <i>NETGEAR Inc.</i> , declares that this Radiolan is in compliance with the essential requirements and other relevant provisions of Directive 1999/5/EC.

Español [Spanish]	Por medio de la presente <i>NETGEAR Inc.</i> declara que el Radiolan cumple con los requisitos esenciales y cualesquiera otras disposiciones aplicables o exigibles de la Directiva 1999/5/CE.
Ελληνική [Greek]	ΜΕ ΤΗΝ ΠΑΡΟΥΣΑ <i>NETGEAR Inc.</i> ΔΗΛΩΝΕΙ ΟΤΙ Radiolan ΣΥΜΜΟΡΦΩΝΕΤΑΙ ΠΡΟΣ ΤΙΣ ΟΥΣΙΩΔΕΙΣ ΑΠΑΙΤΗΣΕΙΣ ΚΑΙ ΤΙΣ ΛΟΙΠΕΣ ΣΧΕΤΙΚΕΣ ΔΙΑΤΑΞΕΙΣ ΤΗΣ ΟΔΗΓΙΑΣ 1999/5/ΕΚ.
Français [French]	Par la présente <i>NETGEAR Inc.</i> déclare que l'appareil Radiolan est conforme aux exigences essentielles et aux autres dispositions pertinentes de la directive 1999/5/CE.
Italiano [Italian]	Con la presente <i>NETGEAR Inc.</i> dichiara che questo Radiolan è conforme ai requisiti essenziali ed alle altre disposizioni pertinenti stabilite dalla direttiva 1999/5/CE.
Latviski [Latvian]	Ar šo <i>NETGEAR Inc.</i> deklarē, ka Radiolan atbilst Direktīvas 1999/5/EK būtiskajām prasībām un citiem ar to saistītajiem noteikumiem.
Lietuvių [Lithuanian]	Šiuo <i>NETGEAR Inc.</i> deklaruoja, kad šis Radiolan atitinka esminius reikalavimus ir kitas 1999/5/EB Direktyvos nuostatas.
Nederlands [Dutch]	Hierbij verklaart <i>NETGEAR Inc.</i> dat het toestel Radiolan in overeenstemming is met de essentiële eisen en de andere relevante bepalingen van richtlijn 1999/5/EG.
Malti [Maltese]	Hawnhekk, <i>NETGEAR Inc.</i> , jiddikjara li dan Radiolan jikkonforma mal-htigijiet essenzjali u ma provvedimenti oħrajn rilevanti li hemm fid-Direttiva 1999/5/EC.
Magyar [Hungarian]	Alulírott, <i>NETGEAR Inc.</i> nyilatkozom, hogy a Radiolan megfelel a vonatkozó alapvető követelményeknek és az 1999/5/EC irányelv egyéb előírásainak.
Polski [Polish]	Niniejszym <i>NETGEAR Inc.</i> oświadczam, że Radiolan jest zgodny z zasadniczymi wymogami oraz pozostałymi stosownymi postanowieniami Dyrektywy 1999/5/EC.
Português [Portuguese]	<i>NETGEAR Inc.</i> declara que este Radiolan está conforme com os requisitos essenciais e outras disposições da Directiva 1999/5/CE.
Slovensko [Slovenian]	<i>NETGEAR Inc.</i> izjavlja, da je ta Radiolan v skladu z bistvenimi zahtevami in ostalimi relevantnimi določili direktive 1999/5/ES.
Slovensky [Slovak]	<i>NETGEAR Inc.</i> týmto vyhlasuje, že Radiolan spĺňa základné požiadavky a všetky príslušné ustanovenia Smernice 1999/5/ES.
Suomi [Finnish]	<i>NETGEAR Inc.</i> vakuuttaa täten että Radiolan tyyppinen laite on direktiivin 1999/5/EY oleellisten vaatimusten ja sitä koskevien direktiivin muiden ehtojen mukainen.
Svenska [Swedish]	Härmed intygar <i>NETGEAR Inc.</i> att denna Radiolan står i överensstämmelse med de väsentliga egenskapskrav och övriga relevanta bestämmelser som framgår av direktiv 1999/5/EG.
Íslenska [Icelandic]	Hér með lýsir <i>NETGEAR Inc.</i> yfir því að Radiolan er í samræmi við grunnkröfur og aðrar kröfur, sem gerðar eru í tilskipun 1999/5/EC.
Norsk [Norwegian]	<i>NETGEAR Inc.</i> erklærer herved at utstyret <i>Radiolan</i> er i samsvar med de grunnleggende krav og øvrige relevante krav i direktiv 1999/5/EF.

FCC Requirements for Operation in the United States

FCC Information to User

This product does not contain any user serviceable components and is to be used with approved antennas only. Any product changes or modifications will invalidate all applicable regulatory certifications and approvals

FCC Guidelines for Human Exposure

This equipment complies with FCC radiation exposure limits set forth for an uncontrolled environment. This equipment should be installed and operated with minimum distance of 20 cm between the radiator and your body.

This transmitter must not be co-located or operating in conjunction with any other antenna or transmitter.

FCC Declaration Of Conformity

We NETGEAR, Inc., 4500 Great America Parkway, Santa Clara, CA 95054, declare under our sole responsibility that the model WN802T RangeMax NEXT Wireless-N Access Point complies with Part 15 of FCC Rules. Operation is subject to the following two conditions:

- This device may not cause harmful interference, and
- This device must accept any interference received, including interference that may cause undesired operation.

FCC Radio Frequency Interference Warnings & Instructions

This equipment has been tested and found to comply with the limits for a Class B digital device, pursuant to Part 15 of the FCC Rules. These limits are designed to provide reasonable protection against harmful interference in a residential installation. This equipment uses and can radiate radio frequency energy and, if not installed and used in accordance with the instructions, may cause harmful interference to radio communications. However, there is no guarantee that interference will not occur in a particular installation. If this equipment does cause harmful interference to radio or television reception, which can be determined by turning the equipment off and on, the user is encouraged to try to correct the interference by one or more of the following methods:

- Reorient or relocate the receiving antenna
- Increase the separation between the equipment and the receiver
- Connect the equipment into an electrical outlet on a circuit different from that which the radio receiver is connected
- Consult the dealer or an experienced radio/TV technician for help.

RangeMax NEXT Wireless-N Access Point



Tested to Comply
with FCC Standards
FOR HOME OR OFFICE USE
PY306200049

Modifications made to the product, unless expressly approved by NETGEAR, Inc., could void the user's right to operate the equipment.

Certificate of the Manufacturer/Importer

It is hereby certified that the RangeMax NEXT Wireless-N Access Point has been suppressed in accordance with the conditions set out in the BMPT-AmtsblVfg 243/1991 and Vfg 46/1992. The operation of some equipment (for example, test transmitters) in accordance with the regulations may, however, be subject to certain restrictions. Please refer to the notes in the operating instructions.

The Federal Office for Telecommunications Approvals has been notified of the placing of this equipment on the market and has been granted the right to test the series for compliance with the regulations.

Bestätigung des Herstellers/Importeurs

Es wird hiermit bestätigt, daß das RangeMax NEXT Wireless-N Access Point gemäß der im BMPT-AmtsblVfg 243/1991 und Vfg 46/1992 aufgeführten Bestimmungen entstört ist. Das vorschriftsmäßige Betreiben einiger Geräte (z.B. Testsender) kann jedoch gewissen Beschränkungen unterliegen. Lesen Sie dazu bitte die Anmerkungen in der Betriebsanleitung.

Das Bundesamt für Zulassungen in der Telekommunikation wurde davon unterrichtet, daß dieses Gerät auf den Markt gebracht wurde und es ist berechtigt, die Serie auf die Erfüllung der Vorschriften hin zu überprüfen.

Product and Publication Details

Model Number:	WN802T
Publication Date:	August 2007
Product Family:	Wireless Access Point
Product Name:	RangeMax NEXT Wireless-N Access Point
Home or Business Product:	Business
Language:	English
Publication Part Number:	202-10204-03

Contents

About This Manual

Conventions, Formats and Scope	ix
How to Use This Manual	x
How to Print this Manual	x
Revision History	xi

Chapter 1

Introduction

About the RangeMax NEXT Wireless-N Access Point	1-1
Key Features	1-1
System Requirements	1-2
What's in the Box	1-3
Front Panel of the RangeMax NEXT	1-3
Back Panel of the RangeMax NEXT	1-5
RangeMax NEXT Default Settings Location	1-5
Wall Mount Kit	1-6

Chapter 2

Installation and Configuration

Wireless Equipment Placement and Range Guidelines	2-1
System Requirements	2-2
Configuring the RangeMax NEXT	2-3
Setting Your Basic LAN Settings	2-3
Configuring Your Wireless Settings	2-7
Verifying Basic Wireless Connectivity	2-9
Deploying the RangeMax NEXT	2-10
Installing the Wall Mount Kit (Optional)	2-10
Configuring and Testing Your PCs for Wireless Connectivity	2-11
Logging in to the RangeMax NEXT	2-12

Chapter 3

Wireless Security Settings

Understanding WN802T Wireless Security Options	3-1
WEP/WPA Settings	3-2
SSID and WEP/WPA Settings Setup Form	3-4
Configuring WEP	3-5
Configuring WPA-PSK, WPA2-PSK and WPA-PSK + WPA2-PSK	3-7
Configuring WPA with Radius, WPA2 with Radius, and WPA + WPA2 with Radius	3-8
Restricting Wireless Access by MAC Address	3-10

Chapter 4

Management

Rebooting the RangeMax NEXT	4-5
Viewing the Statistics	4-6
Configuring the Advanced Wireless Settings	4-7
Configuring the RADIUS Server Settings	4-9

Chapter 5

Advanced Wireless Bridging

Configuring Wireless Multi-Point Bridging	5-1
Configuring Repeater with Wireless Client Association	5-4

Chapter 6

Troubleshooting

No lights are lit on the access point.	6-1
The Ethernet light is not lit.	6-1
The WLAN light is not lit.	6-1
I cannot configure the access point from a browser.	6-2
I cannot access the Internet or the LAN with a wireless capable computer.	6-2
When I enter a URL or IP address I get a timeout error.	6-3
Using the Reset Button to Restore Factory Default Settings	6-3

Appendix A

Default Settings and Technical Specifications

Factory Default Settings	A-1
Technical Specifications	A-3

Appendix B

Related Documents

Index

About This Manual

The *NETGEAR® RangeMax™ NEXT Wireless-N Access Point WN802T Reference Manual* describes how to install, configure and troubleshoot the RangeMax NEXT Wireless-N Access Point. The information in this manual is intended for readers with intermediate computer and Internet skills.

Conventions, Formats and Scope

The conventions, formats, and scope of this manual are described in the following paragraphs:

- **Typographical Conventions.** This manual uses the following typographical conventions

<i>Italic</i>	Emphasis, books, CDs, file and server names, extensions
Bold	User input, IP addresses, GUI screen text
Fixed	Command prompt, CLI text, code
<i>italic</i>	URL links

- **Formats.** This manual uses the following formats to highlight special messages:

	Note: This format is used to highlight information of importance or special interest.
---	--

	Tip: This format is used to highlight a procedure that will save time or resources.
---	--

	Warning: Ignoring this type of note may result in a malfunction or damage to the equipment.
---	--



Danger: This is a safety warning. Failure to take heed of this notice may result in personal injury or death.

- **Scope.** This manual is written for the RangeMax NEXT according to these specifications:

Product Version	RangeMax NEXT Wireless-N Access Point
Manual Publication Date	August 2007





For more information about network, Internet, firewall, and VPN technologies, see the links to the NETGEAR website in [Appendix B, “Related Documents”](#).



Note: Product updates are available on the NETGEAR, Inc. website at <http://kbserver.netgear.com/products/WN802T.asp>.

How to Use This Manual

The HTML version of this manual includes the following:

- Buttons,  and , for browsing forwards or backwards through the manual one page at a time
- A  button that displays the table of contents and an  button. Double-click on a link in the table of contents or index to navigate directly to where the topic is described in the manual.
- A  button to access the full NETGEAR, Inc. online KnowledgeBase for the product model.
- Links to PDF versions of the full manual and individual chapters.

How to Print this Manual

To print this manual you can choose one of the following several options, according to your needs.

- **Printing a Page in the HTML View.** Each page in the HTML version of the manual is dedicated to a major topic. Use the *Print* button on the browser toolbar to print the page contents.

- **Printing a Chapter.** Use the *PDF of This Chapter* link at the top left of any page.
 - Click the *PDF of This Chapter* link at the top right of any page in the chapter you want to print. The PDF version of the chapter you were viewing opens in a browser window.
 - Your computer must have the free Adobe Acrobat reader installed in order to view and print PDF files. The Acrobat reader is available on the Adobe Web site at <http://www.adobe.com>.
 - Click the print icon in the upper left of the window.



Tip: If your printer supports printing two pages on a single sheet of paper, you can save paper and printer ink by selecting this feature.

- **Printing the Full Manual.** Use the *Complete PDF Manual* link at the top left of any page.
 - Click the Complete PDF Manual link at the top left of any page in the manual. The PDF version of the complete manual opens in a browser window.
 - Click the print icon in the upper left of the window.

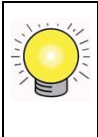

Tip: If your printer supports printing two pages on a single sheet of paper, you can save paper and printer ink by selecting this feature.

Revision History

Part Number	Version Number	Date	Description
202-10204-02	1.4	April 2007	New features: WMM/QoS; WPA2; RADIUS authentication
202-10204-03	1.0	August 2007	New features: Wireless Bridge and Repeat Mode

Chapter 1

Introduction

This chapter describes some of the key features of the NETGEAR RangeMax NEXT Wireless-N Access Point. It also includes the minimum prerequisites for installation (“[System Requirements](#)” on page 1-2.), package contents (“[What’s in the Box](#)” on page 1-3) and a description of the front and back panels of the WN802T (“[Front Panel of the RangeMax NEXT](#)” on page 1-3).

About the RangeMax NEXT Wireless-N Access Point

The WN802T extends your home or small business network by providing high-speed wireless access of up to 300 Mbps¹, with Gigabit wired support at the back end. RangeMax NEXT WN802T is compliant with draft 802.11n. This next generation wireless standard utilizes advanced MIMO (Multi-In, Multi-Out) technology, which delivers incredible speed and range, and for the first time provides wireless interoperability at the highest speeds with other products such as Top Dog™.

A RangeMax NEXT wireless network creates and maintains stable connections and enough bandwidth to surf the Internet, check email, make Internet phone calls, share files and stream high-definition videos, simultaneously, at any distance or location in the home or office. RangeMax NEXT is compatible with all legacy b and g wireless products.

Preset internal antenna and draft 11n-True-Test high-performance testing and tuning provides maximum performance and high-quality streaming every time.

Key Features

The RangeMax NEXT is easy-to-use and provides the following features:

- RangeMax™ Multi-In, Multi-Out (MIMO) technology
- Complies with draft 802.11n², and is backwards compatible with 802.11b/g.

1. Maximum wireless signal derived from IEEE standard 802.11 specification. Actual data throughput will vary. Network conditions and environmental factors, including volume of network traffic, building materials and construction and network overhead, lower actual data throughput rate.

2. Ibid.

- Delivers stable, application enhancing connections using Steady-Stream technology.
- Wi-Fi Protected Access 2 (WPA2) encryption and authentication
- RADIUS authentication support
- Easy, Web-based setup for installation and management.
- NetBIOS login capability.
- Front panel LEDs for easy monitoring of status and activity.
- Flash memory for firmware upgrades.
- Wi-Fi Multimedia (WMM) Quality of Service (QoS) which allows time-dependent information, such as video or audio, to have a higher priority than normal traffic. To implement WMM correctly, wireless clients must also support WMM. (Not available in Client Mode.)
- Operates in three modes for maximum flexibility:
 - **Access Point.** In this mode, operates as a standard 802.11b/g wireless access point.
 - **Wireless Multi-Point Bridging.** In this mode, acts as the “master” for a group of bridge-mode wireless stations.
 - **Repeater with Wireless Client Association.** In this mode, operates as both a wireless access point and a wireless bridge.

System Requirements

Before installing the WN802T, make sure your system meets these requirements.

- A 10/100/1000 Mbps Local Area Network device such as a hub, router, or switch.
- The Category 5 UTP straight through Ethernet cable with RJ-45 connector included in the package, or one like it.
- A 100-240 V, 50-60 HZ AC Switching Power Supply.
- A Web browser for configuration such as Microsoft Internet Explorer 6.0 or above, Netscape Navigator 4.78 or above or Mozilla Firefox.
- At least one computer with the TCP/IP protocol installed.
- 802.11b/g/Next or 802.11b/g -compliant devices.

What's in the Box

The product package should contain the following items:

- RangeMax NEXT Wireless-N Access Point.
- 12V, 1.5A Switching Power Supply
- Vertical stand
- Category 5 (CAT5) Ethernet cable.
- *Resource CD*
- *NETGEAR RangeMax™ NEXT Wireless-N Access Point WN802T Installation Guide*
- Wall mount kit.
- Warranty and Support Information Card.

If any of the parts are incorrect, missing, or damaged, contact your NETGEAR dealer. Keep the carton, including the original packing materials, in case you need to return the router for repair.

Front Panel of the RangeMax NEXT

The front panel of the RangeMax NEXT houses three LEDs that display the status of power to the wireless access point, Ethernet connectivity and whether a wireless signal is being sent. To identify the status lights on the front panel of the WN802T and verify connection, refer to [Table 1-1](#) below.

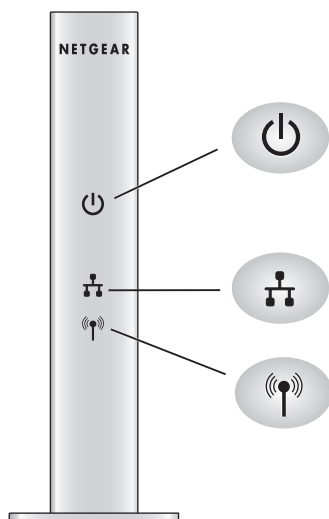





Figure 1-1

You can use the status lights on the front of the wireless access point to verify various conditions described in the following table

Table 1-1. Status Light Descriptions

Label	Activity	Description
Power 	On -- Green Solid Off Solid Amber Blinking Amber	Power is supplied the and the WN802T has passed its diagnostic test. Power is not supplied to the router. System is being initialized. Firmware upgrade is in progress.
Ethernet 	On -- Amber On -- Green Blink -- Amber or Green Off	The Ethernet port has detected a connection at either 10 Mbps or 100 Mbps. The Ethernet port has detected a connection at 1000 Mbps. Data is being transmitted. No ethernet link.
WLAN 	On – Slow blink On – Fast blink Off	The Wireless port is initializing and the wireless feature is enabled. Indicates that a WLAN signal is being sent Wireless radio is turned off.

Back Panel of the RangeMax NEXT

The back of the WN802T contains the items listed below:

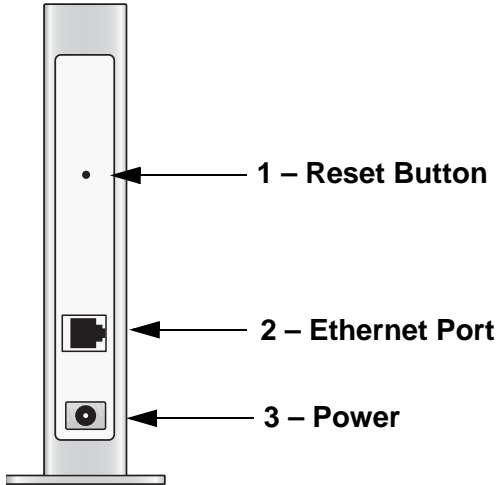

Figure 1-2

Viewed from top to bottom:

1. The reset button which can be used to reset the WN802T or restore the factory default settings. See [Appendix A, “Default Settings and Technical Specifications”](#) for more information on restoring the factory default settings.
2. The Ethernet port for establishing a 10 Mbps, 100 Mbps or 1000 Mbps connection with the network.
3. AC Universal Power Supply outlet.

RangeMax NEXT Default Settings Location

The label on the rear panel of the wireless access point contains the serial number, MAC address and default login information for your WN802T device.



Figure 1-3

Wall Mount Kit

A Wall Mount kit that allows you to conveniently and securely mount your WN802T to a wall is included with your wireless access point. The kit includes a top and bottom bracket. Four screws are required to install the brackets and are not supplied with the kit. For instructions to install the the wall mount kit, see [“Installing the Wall Mount Kit \(Optional\)”](#) on page 2-10.

Chapter 2

Installation and Configuration

This chapter describes how to set up your RangeMax NEXT Wireless-N Access Point for wireless connectivity to your LAN. This basic configuration will enable computers with 802.11b/g/Next or 802.11b/g wireless adapters to connect to the Internet, or access printers and files on your LAN.



Note: Indoors, computers can connect over 802.11b/g/Next or 802.11b/g wireless networks at ranges of several hundred feet or more. This distance can allow for others outside your area to access your network. It is important to take appropriate steps to secure your network from unauthorized access. The RangeMax NEXT provides highly effective security features which are covered in detail in [“Understanding WN802T Wireless Security Options”](#) on page 3-1. Deploy the security features appropriate to your needs

You need to prepare these three things before you can establish a connection through your wireless access point:

- A location for the WN802T that conforms to the [“Wireless Equipment Placement and Range Guidelines”](#) below.
- The wireless access point connected to your LAN through a device such as a hub, switch, router, or Cable/DSL gateway.
- One or more computers with properly configured 802.11b/g/Next or 802.11b/g wireless adapters.

Wireless Equipment Placement and Range Guidelines

The operating distance or range of your wireless connection can vary significantly based on the physical placement of the wireless access point. The latency, data throughput performance, and notebook power consumption of wireless adapters also vary depending on your configuration choices.



Note: Failure to follow these guidelines can result in significant performance degradation or inability to wirelessly connect to the WN802T. For complete performance specifications, see [Appendix A, “Default Settings and Technical Specifications”](#).

For best results, place your wireless access point:

- Near the center of the area in which your PCs will operate.
- In an elevated location such as a high shelf where the wirelessly connected PCs have line-of-sight access (even if through walls).
- Away from sources of interference, such as PCs, microwaves, and 2.4 GHz cordless phones.
- Away from large metal surfaces.

A Wall Mount Kit is provided with your wireless access point. For installation instructions, see [“Installing the Wall Mount Kit \(Optional\)” on page 2-10](#).

If using multiple access points, it is better if adjacent access points use different radio frequency Channels to reduce interference. The recommended Channel spacing between adjacent access points is 5 Channels (for example, use Channels 1 and 6, or 6 and 11).

The time it takes to establish a wireless connection can vary depending on both your security settings and placement. Some types of security connections can take slightly longer to establish and can consume more battery power on a notebook computer.

System Requirements

Before installing the WN802T, make sure your system meets these requirements:

- A 10/100/1000 Mbps Local Area Network device such as a hub, router, or switch.
- The Category 5 UTP straight through Ethernet cable with RJ-45 connector included in the package, or one like it.
- The 100-240 V, 50-60 HZ AC Switching Power Source that came with your device.
- A Web browser for configuration such as Microsoft Internet Explorer 6.0 or above, Netscape Navigator 4.78 or above or Mozilla Firefox.
- At least one computer with the TCP/IP protocol installed.
- 802.11n-compliant wireless adapters or 802.11b/g-compliant devices.

Configuring the RangeMax NEXT

Before installing the RangeMax NEXT Wireless-N Access Point, you should make sure that your Ethernet network is up and working. You will be connecting the access point to the Ethernet network so that computers with 802.11Next/b/g or 802.11b/g wireless adapters will be able to communicate with computers on the Ethernet network. In order for this to work correctly, verify that you have met all of the system requirements, shown on [“System Requirements” on page 1-2](#).

To log into the RangeMax NEXT:

1. Prepare a computer with an Ethernet adapter. If this computer is already part of your network, record its TCP/IP configuration settings.
2. Turn on your computer and configure your computer with a static IP address of 192.168.0.210 and 255.255.255.0 for the Subnet Mask.
3. Connect an Ethernet cable from the WN802T to the computer.
4. Connect the power adapter to the WN802T and verify the following:
 - The PWR power light goes on.
 - The Ethernet port of the wireless access point is lit when connected to a powered on computer.
 - The WLAN LED should be blinking.

Setting Your Basic LAN Settings

The following sections describe how to log in to the wireless access point and to configure your basic LAN settings.

To configure the WN802T for LAN access:

1. Connect to the WN802T by opening a browser window on your PC and entering **http://192.168.0.233** in the address field. The WN802T login screen will appear.
2. Enter **admin** for the user name and **password** for the password, both in lower case letters.



Figure 2-1

3. Click **OK**. The main menu of the WN802T will display as shown in [Figure 2-2](#).
 - When the wireless access point is connected to the Internet, you can select the Documentation link under the Web Support menu to view the documentation for the wireless access point.
 - When connected to the Internet, you can also select KnowledgeBase to access Application Notes relevant to wireless networking.
 - Select Logout to exit the WN802T setup screens. (You will automatically be logged out of the wireless access point after 5 minutes of no activity.)

The screenshot displays the configuration interface for the RangeMax NEXT Wireless-N Access Point WN802T. On the left is a dark blue navigation menu with categories: General, Setup, Security, Management, Information, Advanced, and Web Support. The main content area is titled 'General' and is divided into three sections: Access Point Information, Current IP Settings, and Current Wireless Settings. On the right is a blue sidebar titled 'General Information Help' containing explanatory text and links to 'Access Point Information' and 'Current Wireless Settings'.

General	
Access Point Information	
Access Point Name	netgearDD5382
MAC Address	00:14:6C:DD:53:82
Country / Region	United States
Firmware Version	1.3.11
Access Point Mode	ON
Current IP Settings	
IP Address	192.168.0.233
Subnet Mask	255.255.255.0
Default Gateway	192.168.0.1
LAN MAC Address	00:14:6C:DD:53:82
DHCP Client	Disable
Current Wireless Settings	
Operating Mode	11b/g/Next (20/40 MHz)
Wireless Network Name (SSID)	NETGEAR
Channel / Frequency	1 / 2.412GHz
WEP / WPA	Disable

General Information Help

The *Access Point General Information* page displays current settings of your Access Point. As this information is read-only, any changes must be made on other pages.

Access Point Information: General information.

Current IP Settings: These are the current settings for IP address, Subnet Mask, Default Gateway and DHCP settings.

Current Wireless Settings: These are the current wireless settings for the Access Point.

Figure 2-2

To configure the Basic LAN settings:

1. Select **Basic Settings** under **Setup** on left side of the main menu. The Basic Settings screen will display. The default settings should be suitable for most users and environments.

Basic Settings

Access Point Name: netgearDD53EB

IP Address

DHCP Client: Enable Disable

IP Address: 192 . 168 . 0 . 233

IP Subnet Mask: 255 . 255 . 255 . 0

Default Gateway: 192 . 168 . 0 . 1

Primary DNS Server: 0 . 0 . 0 . 0

Secondary DNS Server: 0 . 0 . 0 . 0

Time Zone: (GMT-08:00) Pacific Time (US Canada) ▼

Automatically Adjust for Daylight Savings Time

Current Time: Thu Jan 1 19:20:28 1970

Apply Cancel

Figure 2-3

2. Enter the **Access Point Name** of the WN802T.

This unique name is the access point NetBIOS name. The Access Point Name is printed on the rear label of the WN802T. The default is **netgearxxxxxx**, where **xxxxxxx** represents the last 6 digits of the WN802T MAC address. You may modify the default name with a unique name up to 15 characters long.

3. Enter the IP Address fields of the WN802T.

- **DHCP Client.** By default, the Dynamic Host Configuration Protocol (DHCP) client is disabled. If you have a DHCP server on your LAN and you enable DHCP, the wireless access point will get its IP address, subnet mask and default gateway settings automatically from the DHCP server on your network when you connect the WN802T to your LAN.
- **IP Address.** Enter the IP Address of your wireless access point. The default IP address is 192.168.0.233. To change it, enter an unused IP address from the address range used on your LAN; or enable DHCP.
- **IP Subnet Mask.** The Access Point will automatically calculate the subnet mask based on the IP address that you assign. Otherwise, you can use 255.255.255.0 (the default) as the subnet mask.

- **Default Gateway.** Enter the IP address of the gateway for your LAN. For more complex networks, enter the address of the router for the network segment to which the wireless access point is connected. The default is 0.0.0.0.
 - **Primary DNS Servers.** The WN802T will use this IP address as the primary Domain Name Server used by stations on your LAN. The default is 0.0.0.0.
 - **Secondary DNS Servers.** The WN802T will use this IP address as the secondary Domain Name Server used by stations on your LAN. The default is 0.0.0.0.
4. From the pull-down menu, select the local **Time Zone** for your wireless access point from a list of all available time zones. The default is GMT.-08:00
 5. Check the **Adjust for Daylight Saving Time** if your location uses daylight savings. The default is no adjustment.



Note: If you do not have an Internet connection to get the current time, the wireless access point will get the current time from the connecting PC.

6. Click **Apply** to save your Basic IP settings.



Note: If you change the default subnet of the LAN IP address, you will be disconnected from the RangeMax NEXT user interface. To reconnect, reconfigure your computer with a static IP address within the new LAN IP subnet.

By default, the WN802T is set with the DHCP client disabled. If your network uses dynamic IP addresses, you must change this setting (see [“Logging in to the RangeMax NEXT” on page 2-12](#)),

Configuring Your Wireless Settings

The following sections describe how to configure the wireless settings for both the 802.11b/g/Next and 802.11b/g modes.

To configure the RangeMax NEXT wireless settings of your wireless access point:

1. From the main menu under Setup, select **Wireless Settings**. The Wireless Settings screen will display as shown in [Figure 2-4](#) below

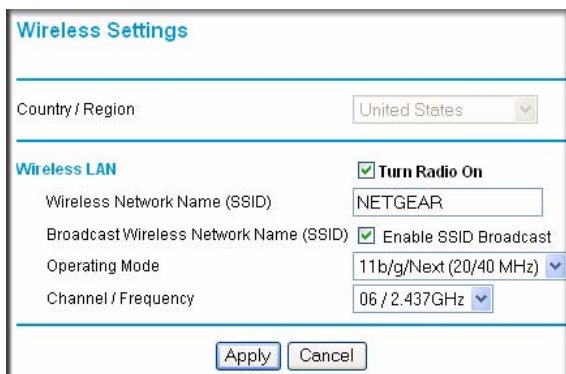

Wireless Settings

Country / Region: United States

Wireless LAN

Turn Radio On

Wireless Network Name (SSID): NETGEAR

Broadcast Wireless Network Name (SSID): Enable SSID Broadcast

Operating Mode: 11b/g/Next (20/40 MHz)

Channel / Frequency: 06 / 2.437GHz

Apply Cancel

Figure 2-4

- From the **Country/Region** pull-down menu, select the region where the WN802T can be used (the Country/Region is not Configurable in the United States; but is configurable in the rest of the world).

	Note: If your country or region is not listed, please check with your local government agency.
---	---

- Configure the Wireless LAN settings based on the following field descriptions:
 - Turn Radio On.** On by default, you can also turn off the radio to disable access through this device. This can be helpful for configuration, network tuning, or troubleshooting activities.
 - Wireless Network Name (SSID).** Enter a 32-character (maximum) service set ID in this field; the characters are case sensitive. When the wireless access point is deployed in “infrastructure” mode, the SSID assigned to a wireless device must match the wireless access point SSID in order for the wireless device to communicate with the WN802T. If they do not match, you will not get a wireless connection to the WN802T. The default is NETGEAR.
 - Broadcast Wireless Network Name (SSID).** If Enabled, the Wireless Access Point broadcasts its SSID allowing Wireless Stations which have a “null” (blank) SSID to adopt the correct SSID. If set to disable, the SSID is not broadcast. The default is Enabled.
 - Wireless Mode.** From the pull-down menu, select the desired wireless operating mode:
 - 11b/g – Both 802.11b and 802.11g wireless stations can be used.

- 11b/g/Next – 802.11b, 802.11g and 802.11n wireless stations can be used.

The default is 11b/g/Next

- **Channel/Frequency.** From the pull-down menu, select the channel you wish to use on your wireless LAN. The wireless channels to use in the U.S. and Canada are 1 to 11; for Europe and Australia, 1 to 13. The default is channel 6.

It should not be necessary to change the wireless channel unless you experience interference (shown by lost connections and/or slow data transfers). Should this happen, you may want to experiment with different channels to see which is the best. See the article on “Wireless Channels” available on the NETGEAR website. (A link to this article and other articles of interest can be found in [Appendix B, “Related Documents.”](#))

4. Click **Apply** to save your wireless settings.

Verifying Basic Wireless Connectivity

Follow the instructions below to set up and test basic wireless connectivity. Once you have established basic wireless connectivity, you can enable security settings appropriate to your needs (see [“Wireless Security Settings”](#)).

1. From a web browser, log in to the WN802T using its default address of **http://192.168.0.233**. Use the default user name of **admin** and default password of **password**—or use a new LAN address and password if you have set them up.
2. From the main menu under Setup, select Basic Settings. Verify that the correct Country/Region in which the wireless interface will operate has been selected.
3. Click **Apply** to save any changes.
4. From the main menu under Setup, verify your Operating Mode—either 11b/g/Next or 11b/g. Verify that the correct (default) channel has been selected for your network.

It should not be necessary to change the wireless channel unless you notice interference problems or are near another wireless access point. Select a channel that is not being used by any other wireless networks within several hundred feet of your wireless access point.

Click **Apply** to save any changes.



Note: If you are unable to connect, see [Chapter 6, “Troubleshooting.”](#)

Deploying the RangeMax NEXT

Now that you have completed the setup steps, you can deploy the WN802T in your network. If needed, you can now reconfigure the computer you used in step 1 in [“Configuring the RangeMax NEXT” on page 2-3](#) back to its original TCP/IP settings.

To deploy the RangeMax NEXT:

1. Disconnect the WN802T and position it where it will be deployed. The best location is elevated, such as wall mounted or on the top of a cubicle, at the center of your wireless coverage area, and within line of sight of all the mobile devices.
2. Connect an Ethernet cable from your RangeMax NEXT to a LAN port on your router, switch, or hub. Connect the power adapter to the wireless access point and plug the power adapter into a power outlet. The PWR, LAN, and Wireless LAN LEDs and should light up



Tip: Before mounting the WN802T in a high location, first set up and test the WN802T to verify wireless network connectivity.

Installing the Wall Mount Kit (Optional)

Before you begin installation, check to make sure that the four screws selected to secure the brackets fit flush within the molding of the bracket. An illustration of the installation steps is shown in [Figure 2-5 on page 2-11](#).

To install the wireless access point mounting brackets:

1. Place the bottom bracket on the wall where you want to install the WN802T. Securely screw the bottom bracket into the wall, making sure the screws are flush with the bracket (Step 1).
2. Snap the WN802T into place on the bottom bracket (Step 2). The tabs on the bottom of the bracket will snap into the slots on the bottom of the WN802T.
3. Firmly secure the top bracket onto the WN802T and attach the bracket with two additional screws (Step 3). Ensure that the bracket flange engages with the top lip of the WN802T before screwing in the bracket.

Should you need to remove the WN802T, unscrew the top bracket, and then unsnap the WN802T from the bottom bracket. Never try to remove your wireless access point before removing the top bracket.

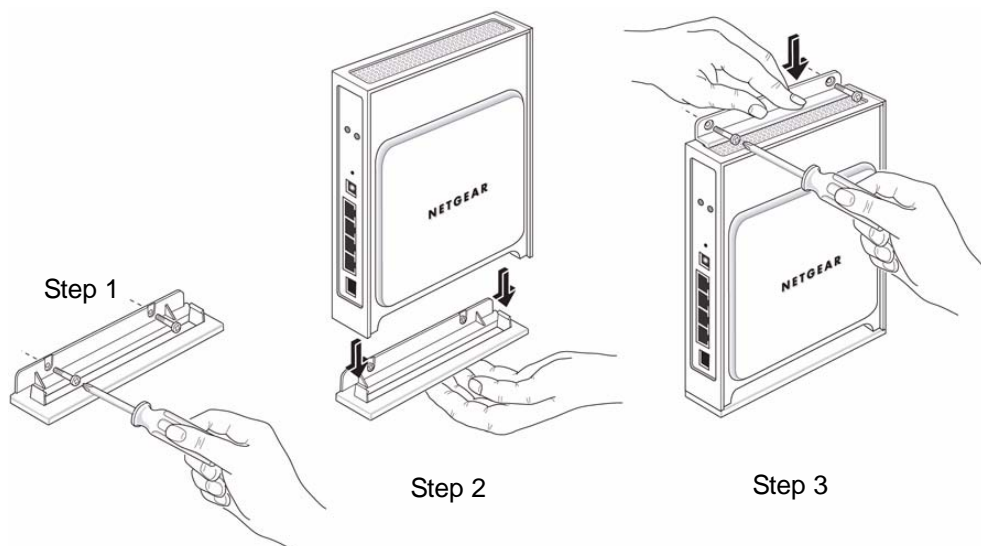

Figure 2-5

Configuring and Testing Your PCs for Wireless Connectivity

Program the wireless adapter of your PCs to have the same SSID and channel that you configured in **Wireless Settings** for the WN802T. Check that they have a wireless link and are able to obtain an IP address by DHCP from the WN802T.



Note: If you are configuring the WN802T from a wireless computer and you change the SSID, channel, or Security Profile settings, you will lose your wireless connection when you click Apply. You must then change the wireless settings of your computer to match the new settings.

Once your PCs have basic wireless connectivity to the WN802T, you can deploy the WN802T and configure the advanced wireless security functions.

Logging in to the RangeMax NEXT

The WN802T is set, by default with the IP address of 192.168.0.233 with DHCP disabled.

	Note: If logging in using the default IP address, the computer you are using to connect to the WN802T should be configured with an IP address that starts with 192.168.0.x and a Subnet Mask of 255.255.255.0.
---	---

If DHCP is enabled, there are two methods you can use to connect to the WN802T after the DHCP server on your network assigns it a new IP address.

- If your wireless access point is to be deployed on a local network, you can enter the NetBIOS¹ name into your Web browser. The default wireless access point name is **netgearxxxxxx**, where **xxxxxx** represents the last 6 bytes of the MAC address. The MAC address is printed on the rear label of the WN802T. (Using the NetBIOS naming convention to access your router across several network segments is known to be unreliable.)
- Reserve an IP address (based on the WN802T's MAC address) on the DHCP server. That way, if your router is deployed across several segments, you can configure the wireless access point with a static IP address which you can always use to log in to make future configuration changes.

To log in using the default IP Address:

1. Open a Web browser such as Mozilla Firefox, Internet Explorer or Netscape Navigator.
2. Connect to the WN802T by entering the default address of **http://192.168.0.233** into your browser.



Figure 2-6

1. NetBIOS name login is not supported in the initial release of the firmware. Check the Release Notes of your firmware version for NetBIOS support at <http://kbserver.netgear.com/products/WN802T.asp>.

3. The login screen will display. Enter **admin** for the user name and **password** for the password, both in lower case letters.



Figure 2-7

4. Click **OK**.

Your Web browser should automatically find the RangeMax NEXT and display the home screen, as shown in [Figure 2-7](#) above.

Chapter 3

Wireless Security Settings

Your wireless data transmissions can be received well beyond your walls by anyone with a compatible adapter. For this reason, use the security features of your wireless equipment. The RangeMax NEXT provides highly effective security features which are covered in detail in this chapter. Deploy the security features appropriate to your needs.

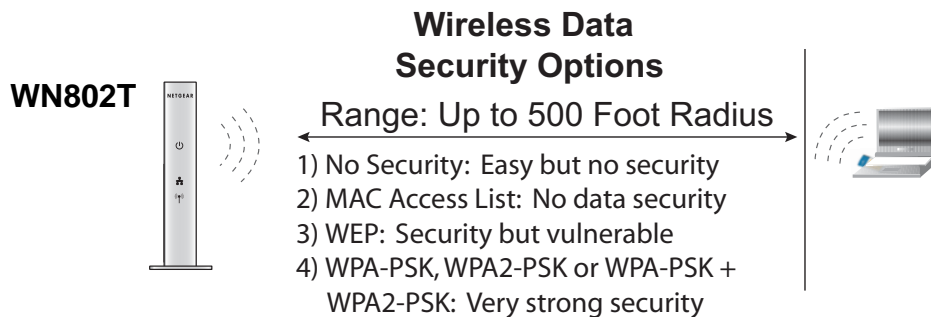

Figure 3-1

Understanding WN802T Wireless Security Options

There are several ways you can enhance the security of your wireless network:

- **Restrict Access Based on MAC address.** You can restrict access to only trusted PCs so that unknown PCs cannot wirelessly connect to the WN802T. MAC address filtering adds an obstacle against unwanted access to your network, but the data broadcast over the wireless link is fully exposed.
- **Turn Off the Broadcast of the Wireless Network Name (SSID).** If you disable broadcast of the SSID, only devices that have the correct SSID can connect. This nullifies the wireless network “discovery” feature of some products such as Windows XP, but the data is still fully exposed to a determined snoop using specialized test equipment like wireless sniffers.
- **Use WEP.** Wired Equivalent Privacy (WEP) data encryption provides data security. WEP Shared Key authentication and WEP data encryption will block all but the most determined eavesdropper.

- **Use WPA-PSK or WPA2-PSK.** Wi-Fi Protected Access (WPA) provides stronger data encryption than WEP. The very strong authentication along with dynamic per frame rekeying of WPA make it virtually impossible to compromise. The preshared key (PSK) is common to all users. Because this is a recent standard, wireless device driver and software availability may be limited.
- **Use WPA-PSK or WPA2-PSK with RADIUS.** Using a Remote Authentication Dial In User Service (RADIUS) authentication server allows centralized authentication management with individual user names and passwords.

WEP/WPA Settings

The WN802T Access Point is set by default “None” or no authentication. When setting up Network Authentication, bear in mind the following:

Not all wireless adapters support WPA or WPA2. Windows XP and Windows 2000 with Service Pack 3 do include the client software that supports WPA. However, client software is required on the client. Consult the product documentation for your wireless adapter and WPA or WPA2 client software for instructions on configuring WPA2 settings.

- **Network Authentication.** You can configure the RangeMax NEXT to use the types of network authentication shown in the table below.

Table 3-1. Network Authentication Types

Type	Description
None	No data encryption
WEP	Wired Equivalent Privacy using either 64-bit or 128-bit data encryption.
WPA-PSK (TKIP)	Wi-Fi Protected Access with Pre-Shared Key, uses WPA-PSK standard encryption with TKIP encryption type.
WPA2-PSK (AES)	Wi-Fi Protected Access with Pre-Shared Key, uses WPA-PSK standard encryption with AES encryption type. Only select this if all clients support WPA2.
WPA-PSK (TKIP) + WPA2-PSK (AES)	This selection allows clients to use either WPA-PSK (TKIP) or WPA2-PSK (AES).
WPA with Radius	If selected, you must configure the Radius Server Settings Screen.
WPA2 with Radius	Only select this if all clients support WPA2. If selected, you must use AES encryption, and configure the Radius Server Settings Screen.
WPA and WPA2 with Radius	If selected, encryption must be TKIP + AES. If selected, you must configure the Radius Server Settings Screen.

- **Data Encryption.** The available options depend on the Network Authentication setting selected (see [Table 3-1](#) above); otherwise, the default is None. The Data Encryption settings are explained in the table below:

Table 3-1. Data Encryption Settings

Data Encryption Type	Description
None	No encryption is used.
64 bits WEP	Standard WEP encryption, using 40/64 bit encryption.
128 bits WEP	Standard WEP encryption, using 104/128 bit encryption.
TKIP	Automatic encryption with WPA-PSK; requires passphrase
AES	Automatic encryption with WPA2-PSK; requires passphrase

- **WEP Authentication Type.** WEP can be authenticated using Open System or Automatic. If set to Open System, clients can only associate to the wireless access point by using the Open System option. If set to Automatic, clients can associate to the wireless access point using both Open System and Shared Key. Setting the Authentication Type to Automatic will detect which WEP authentication method is being used. The default is Automatic.
- Use of Passphrases and Keys are explained below:
 - **Passphrase.** To use the Passphrase to generate the WEP keys, enter a passphrase and click the Generate Keys button. You can also enter the keys directly. These keys must match the other wireless stations.
 - **Key 1, Key 2, Key 3, Key 4.** If using WEP, select the key to be used as the default key. Data transmissions are always encrypted using the default key. The other keys can only be used to decrypt received data.
 - **WPA Preshared Key Passphrase.** If using WPA-PSK, WPA2-PSK or WPA-PSK + WPA2-PSK, enter the passphrase here. All wireless stations must use the same passphrase (network key). The network key must be from 8 to 63 characters in length.

SSID and WEP/WPA Settings Setup Form

For a new wireless network, print or copy this form and fill in the configuration parameters. For an existing wireless network, the person who set up or is responsible for the network will be able to provide this information. Be sure to set the Regulatory Domain correctly as the first step.

- **SSID:** The Service Set Identification (SSID) identifies the wireless local area network. **NETGEAR** is the default WN802T SSID. However, you may customize it by using up to 32 alphanumeric characters. Write your customized SSID on the line below.

Note: The SSID in the wireless access point is the SSID you configure in the wireless adapter card. All wireless nodes in the same network must be configured with the same SSID,

- Circle the type of Security Authentication used in your wireless network, and then fill out the appropriate required encryption parameters:

WEP, WPA-PSK, WPA2-PSK, WPA-PSK + WPA2-PSK

- **WEP Encryption Type:**

Circle one: Automatic or Open System

Note: If you selected Open System, the other devices in the network will not connect unless they are set to Open System, and have the same keys in the same positions as those in the WN802T.

- **WEP Encryption Keys:**

Circle one: 64 or 128 bits. (Enter all four keys for the Key Size chosen.)

Key 1: _____

Key 2: _____

Key 3: _____

Key 4: _____

- **WPA Security Encryption for WPA-PSK, WPA2-PSK or WPA-PSK + WPA2-PSK.**
Record a **Passphrase** between 8 and 63 characters:

Passphrase: _____

Use the procedures described in the following sections to configure the WN802T. Store this information in a safe place.

Configuring WEP

To configure WEP data encryption:

1. Select **WEP/WPA Settings** under the Security menu on the left navigation pane. The WEP/WPA Settings screen will display.

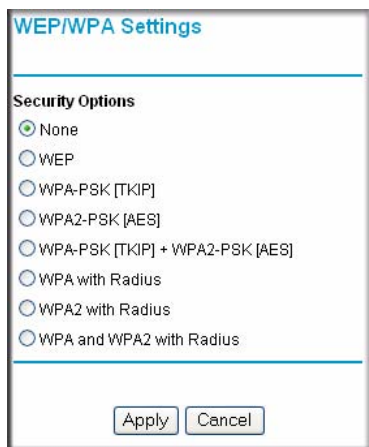

Figure 3-2

2. Check the **WEP** radio button. The WEP Security Encryption options will display. Select the **Authentication Type** from the pull-down menu. The default is Automatic.
3. Selection the Encryption Strength from the pull-down menu; either 64-bit or 128 bit.
4. You can manually or automatically program the four data encryption keys. These values must be identical on all PCs and wireless access points in your network. Choose either:
 - **Automatic** – Enter a word or group of printable characters in the Passphrase box and click the Generate button. The four key boxes will be automatically populated with key values.
 - **Manual** – Enter the number of hexadecimal digits appropriate to the encryption strength: 10 digits for 64-bit and 26 digits for 128-bit (any combination of 0-9, a-f, or A-F) Select which of the four keys will be the default.

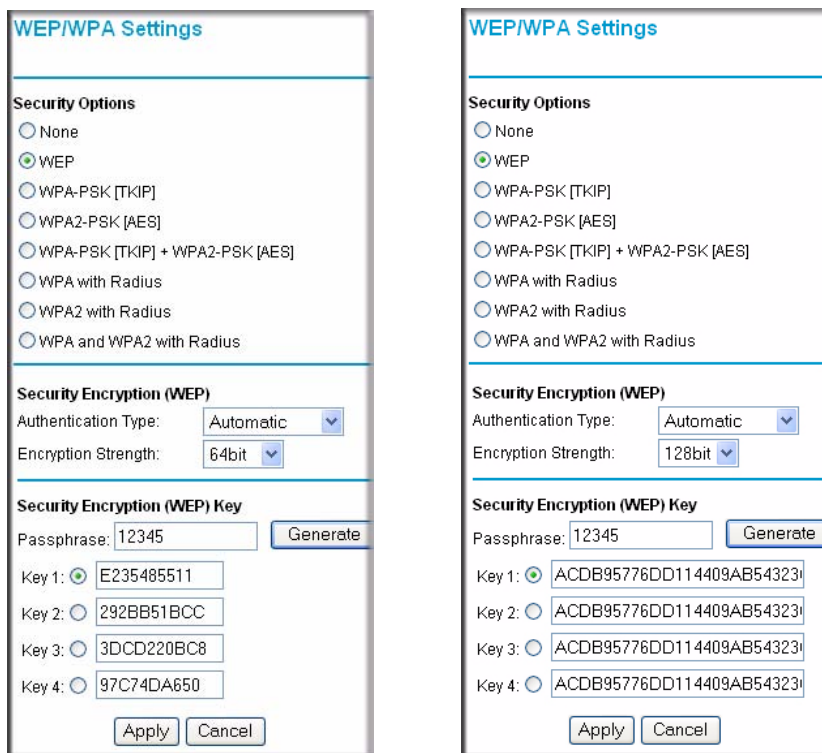



Figure 3-3

5. Select the key to be used as the default key by checking the radio box. (Data transmissions are always encrypted using the default key.)

See the document “Wireless Communications” for a full explanation of each of these options, as defined by the IEEE 802.11 wireless communication standard. A link to this document on the NETGEAR website is in [Appendix B, “Related Documents.”](#)

6. Click **Apply** to save your settings.

	<p>Note: If you use a wireless computer to configure WEP settings, you will be disconnected when you click Apply. Reconfigure your wireless adapter to match the new settings or access the wireless access point from a wired computer to make any further changes.</p>
---	---

Configuring WPA-PSK, WPA2-PSK and WPA-PSK + WPA2-PSK

Not all wireless adapters support WPA. Furthermore, client software is required on the client. Windows XP and Windows 2000 with Service Pack 3 or above include the client software that supports WPA. Nevertheless, the wireless adapter hardware and driver must also support WPA. Consult the product document for your wireless adapter and WPA client software for instructions on configuring WPA settings.

To configure WPA-PSK, WPA2-PSK or WPA-PSK + WPA2-PSK:

1. Select **WEP/WPA Settings** under the **Security** menu on the left navigation pane. The **WEP/WPA Settings** screen will display.

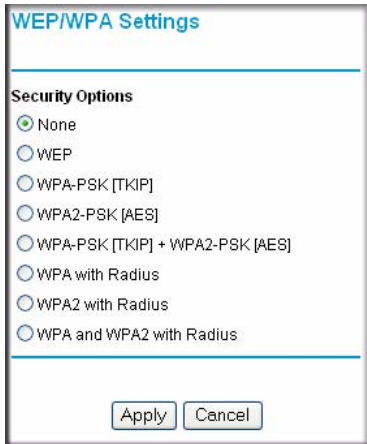

Figure 3-4

2. Select one of the following radio buttons: **WPA-PSK**, **WPA2-PSK** or **WPA-PSK + WPA2-PSK**. The Security encryption Passphrase field will display.

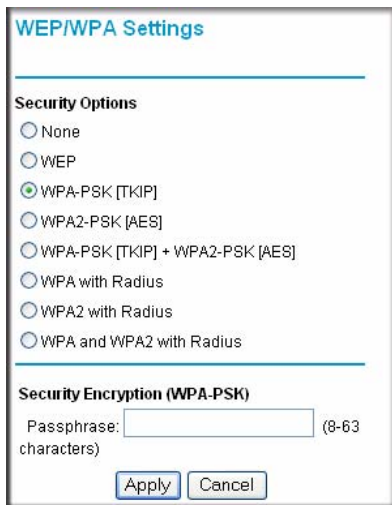

Figure 3-5

3. Enter the preshared key **Passphrase** (Network Key).
4. Click **Apply** to save your settings.

Configuring WPA with Radius, WPA2 with Radius, and WPA + WPA2 with Radius

In an organization with many wireless users, using a single preshared key may not be a practical security method. Deploying a RADIUS server will allow you to manage user authentication individually and centrally.

To configure WPA with Radius, WPA2 with Radius, or WPA + WPA2 with Radius:

1. Select **WEP/WPA Settings** under the **Security** menu on the left navigation pane. The **WEP/WPA Settings** screen will display.

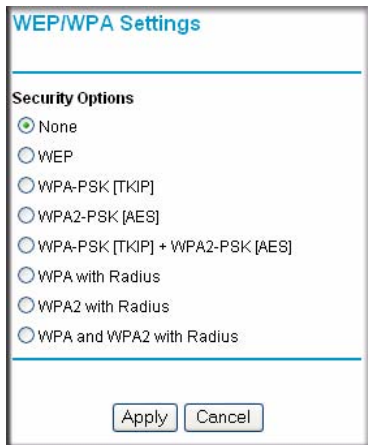
**Figure 3-6**

2. Select one of the following radio buttons: **WPA with Radius**, **WPA2 with Radius**, or **WPA + WPA2 with Radius**. Your selection will display.

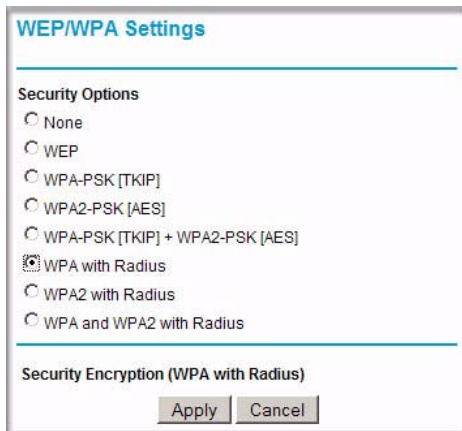
**Figure 3-7**

3. Click **Apply** to save your settings. A message appears informing you that you must configure the Radius Server Settings menu.
4. Click **OK**.
5. Configure the Radius Server Settings menu using the procedure described in [“Configuring the RADIUS Server Settings”](#) on page 4-9.

Restricting Wireless Access by MAC Address

By default, all wireless PCs that are configured with the correct SSID are allowed access to your wireless network. For increased security, you can restrict access to your wireless network to only those trusted wireless PCs based on their MAC address.

The **Access Control List** screen lets you block the network access privilege of any specified stations to only those displayed in the Trusted **Wireless Stations** table. When you enable the **Turn Access Control On** radio box, the access point will only accept connections from those clients on the Trusted Wireless Stations access control list. This provides an additional layer of security.



Note: If configuring the WN802T from a wireless computer whose MAC address is not in the **Trusted Wireless Stations** access control list, when you select **Turn Access Control On**, you will lose your wireless connection when you click **Apply**. You must then access the wireless access point from a wired computer or from a wireless computer which is on the access control list to make any further changes.

To restrict access based on MAC addresses:

1. Log in to the WN802T using the default address of **http://192.168.0.233**, user name of **admin** and default password of **password**, or whatever LAN address and password you have set up.
2. Under Security on the main menu, select **Access Control**. The Access Control menu will display.

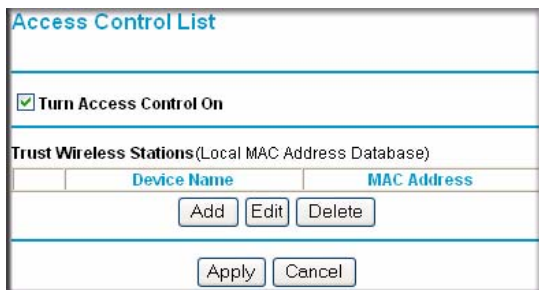



Figure 3-8

3. Check the **Turn Access Control On** radio button.
4. Click **Apply** to enable the Access Control feature.

5. The **Trusted Wireless Stations** table will display any wireless stations you have entered. If you have not entered any wireless stations this list will be empty.

	Note: If Turn Access Control On is enabled and the Access Control List is blank, then no wireless PCs will be able to connect to your wireless network
---	--

To delete an existing entry:

Check the radio button adjacent to the entry and then click **Delete**.

To set up the trusted wireless stations control list:

1. Click **Add** on the Access Control List screen. The **Wireless Card Access Setup** screen will display. The **Available Wireless Cards** table will display all available wireless PCs and their MAC addresses.



Figure 3-9

2. If the wireless PC you want to add appears in the list, check its adjacent radio button and click **Add**.
 - If the PC is not displayed, make sure that it is configured correctly and click **Refresh**.
 - If no wireless PCs appear in the **Available Wireless Cards** access list, then you can manually enter the **Device Name** and **MAC Address** of the wireless PC in the appropriate fields and then click **Add**. (You can usually find the MAC address printed on the bottom of the wireless adapter.)

3. Repeat these steps for each additional device you want to add to the **Trusted Wireless Stations** list.



Note: The wireless stations must be selected and added one at a time to the **Trusted Wireless Stations** list.

4. Click **Apply** to save your wireless access control list settings.

Now, only devices on this list will be allowed to wirelessly connect to the WN802T.

Chapter 4 Management

This chapter describes how to use the management and information features as well as the advanced wireless settings features of your RangeMax NEXT Wireless-N Access Point. These features can be found under the Management, Information and Advanced menus on the left navigation pane of the browser interface.

Changing the Password



Note: Before changing the WN802T password, use the backup utility to save your configuration settings. If you forget your new password, you must reset the WN802T back to the factory defaults and use the default password. Consequently, you will have to restore any WN802T configuration settings you have made. The backup file can be used in this event.

The default password for the WN802T is **password**. NETGEAR recommends that you change this password to a more secure password.

To change the password:

1. Select **Change Password** under the **Management** menu on the left navigation pane. The **Change Password** screen will display.

Set Password

Old Password

New Password

Repeat New Password

Restore Default Password Yes No

Apply Cancel

Figure 4-1

Figure 4-2

2. First enter the old password, in the **Old Password** field.
3. Then enter the new password twice in the **New Password** and **Repeat New Password** fields.
4. Click **Apply** to save your changes.



Note: Be sure to write down the new password and store it in a safe place.

To restore the default password:

1. Check the **Restore Default Password** radio button.
2. Click **Apply**. The default password will be restored.

Upgrading the Wireless Access Point Firmware

The software of the RangeMax NEXT is stored in FLASH memory, and can be upgraded as new software is released by NETGEAR. Upgrade files can be downloaded from the NETGEAR Web site. If the upgrade file is compressed (.ZIP file), you must first extract the image (.img) file before sending it to the wireless access point. The upgrade file can be sent using your browser.



Note: The Web browser used to upload new firmware into the RangeMax NEXT must support HTTP uploads, such as Microsoft Internet Explorer 6.0 or above, or Netscape Navigator 4.78 or above.

To upgrade the firmware:

1. Go to the NETGEAR Web site at http://kbserver.netgear.com/downloads_support.asp to get new versions of the Access Point software.
2. Download, save and unzip (if the download file is a .zip file) the new software file.
3. From the main menu of the browser interface, click **Upgrade Firmware** under the **Management** menu on the left navigation panel. The **Upgrade Firmware** screen will display.



Figure 4-3

4. Click **Browse** and go to the location of the downloaded software upgrade file.
5. Click **Upload**.

	<p>Warning: When uploading firmware to the wireless access point, it is important not to interrupt the Web browser by closing the window, clicking a link, or loading a new page. If the browser is interrupted, the upload may fail, corrupt the software, and render the WN802T inoperable.</p>
---	--

In some cases, it may be necessary to reconfigure the wireless access point after upgrading.

Backing Up or Restoring Settings

You can back up your configuration settings of the RangeMax NEXT and restore the factory default settings. Once you have your wireless access point working properly, backing up the configured settings would be prudent should you have to perform a factory reset. When you backup the settings, they are saved as a file on your computer that you can access to restore the wireless access point's configured settings.

To backup/restore settings:

1. From the main menu of the browser interface, select **Backup/Restore Settings** from under the **Management** menu. The **Backup/Restore Settings** screen will display.

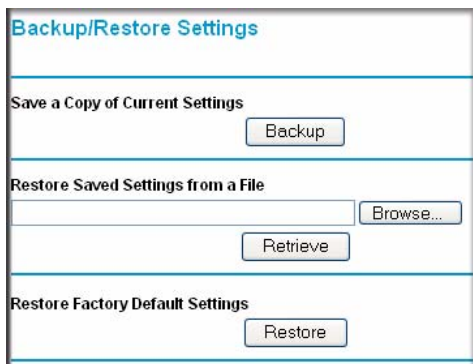
**Figure 4-4**

2. Select the task you want to perform:

- To create a backup file of the current settings, click **Backup** under the **Save a Copy of Current Settings** heading.
 - If you don't have your browser set up to save downloaded files automatically, locate where you want to save the file, rename it if you like, and click Backup.
 - If you have your browser set up to save downloaded files automatically, the file will be automatically saved to the download location
- To restore settings from a backup file:
 - Click **Browse** under the **Restore Saved Settings from a File** heading. Locate and select the previously saved backup file (by default, netgear.cfg).
 - Click **Retrieve**. A window will appear with the message that the wireless access point has been successfully restored to its previous settings. The wireless access point will restart. This will take about one minute.



Warning: Do not try to go online, turn off the Access Point, shut down the computer or do anything else to the Access Point until it finishes restarting. When the Test light turns off, wait a few more seconds before doing anything with the Access Point.

- Close the message window.
- To erase the current settings and reset the wireless access point to the original factory default settings:
 - Click **Restore**. The default factory settings will be restored.

- A list of the factory default settings can be found in [Appendix A, “Default Settings and Technical Specifications”](#).

	Warning: Do not try to go online, turn off the Access Point, shut down the computer or do anything else to the Access Point until it finishes restarting. When the Test light turns off, wait a few more seconds before doing anything with the Access Point.
---	--

Rebooting the RangeMax NEXT

You can reboot the wireless access point from the browser interface or by using the reset button on the rear panel.

To reboot the wireless access point from the user interface:

1. From the main menu of the browser interface, click **Reboot AP** under the **Management** menu on the left navigation pane. The **Reboot AP** screen will display..

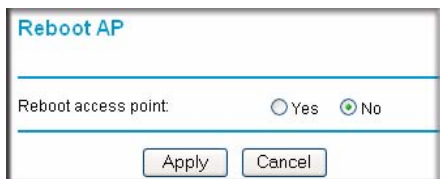

Figure 4-5

2. Select the **Yes** radio button, and then click **Apply**.

Viewing the Available Wireless Station List

The Available Wireless Station List contains a table of all IP devices associated with this wireless access point network defined by its Wireless Network Name (SSID).

To view the list of available wireless stations:

1. From the main menu of the browser interface, select **Available Wireless Station List** under the **Information** menu of the left navigation pane. The **Available Wireless Station List** will display.

2. Click **Refresh** to update the list and force the wireless access point to look for associated devices.



Figure 4-6

- For each device, the table shows the Station ID, MAC address, IP Address, and Status (whether the device is allowed to communicate with the wireless access point or not).
- If the wireless access point is rebooted, the table data is lost until the wireless access point rediscovers the devices.

	<p>Note: A wireless network can include multiple wireless access points, all using the same network name (SSID). This extends the reach of the wireless network and lets users roam from one access point to another which provides seamless network connectivity. Under these circumstances, be aware that only the stations associated with this wireless access point will be presented in the Available Wireless Station List.</p>
---	---

Viewing the Statistics

The Statics screen displays both wired and wireless interface network traffic.

To display statics for the wireless access point:

1. Select **Statistics** under the **Information** menu on the left information pane. The **Statistics** screen will display.

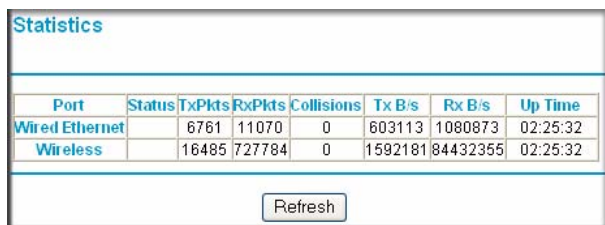

Port	Status	TxPkts	RxPkts	Collisions	Tx B/s	Rx B/s	Up Time
Wired Ethernet		6761	11070	0	603113	1080873	02:25:32
Wireless		16485	727784	0	1592181	84432355	02:25:32

Figure 4-7

- The **Wired Ethernet** section of the table displays traffic statistics for the wired Ethernet interface.
 - The **Wireless** section displays traffic statistics for the wireless interface.
2. Click **Refresh** to update the current statistics.

Configuring the Advanced Wireless Settings

We recommend that the Advanced Wireless Settings should be modified only by an administrator very familiar with the ramifications of changing the Wireless LAN parameters. If set incorrectly, they can adversely affect the performance or connectivity of your wireless access point. The default settings should be adequate in most situations. Following is a description of each of the Wireless LAN Parameters.

- **WMM Support.** Wi-Fi Multimedia (WMM) is a Quality of Service (QoS) feature that provides prioritization of wireless data packets from different applications based on four access categories: voice, video, best effort, and background. For an application to receive the benefits of WMM QoS, both the application and the client running that application must be WMM-enabled. Legacy applications that do not support WMM, and applications that do not require QoS, are assigned to the best-effort category, which receives a lower priority than voice and video.

The default setting is Enabled.

- **RTS Threshold.** The Request to Send Threshold packet size determines if the wireless access point should use the CSMA/CD (Carrier Sense Multiple Access with Collision Detection) mechanism or the CSMA/CA mechanism for packet transmission:
 - With the CSMA/CD transmission mechanism, the transmitting station sends out the actual packet as soon as it has waited for the silence period.

- With the CSMA/CA transmission mechanism, the transmitting station sends out an RTS packet to the receiving station, and waits for the receiving station to send back a CTS (Clear to Send) packet before sending the actual packet data.

The default value is 2346.

- **Fragmentation Length.** This is the maximum packet size used for fragmentation. Packets larger than the size programmed in this field will be fragmented. The Fragment Threshold value must be larger than the RTS Threshold value.

The default value is 2346

- **Beacon Interval.** The Beacon Interval specifies the interval of time between 20ms and 1000ms for each beacon transmission.

The default value is 100 ms.

- **DTIM Interval.** The Delivery Traffic Indication Message Interval specifies the data beacon rate between 1 and 255.

The default value is 1.

- **Preamble Type.** A long transmit preamble may provide a more reliable connection or slightly longer range. A short transmit preamble gives better performance. The Auto setting will automatically handle both long and short preamble.

The default setting is Auto.

The Wireless Optimization Settings feature allows you to adapt the wireless performance depending on the type of wireless clients that will be used in your network. The available settings are:

- **11Next Max Speed.** This setting yields the best Wireless N performance when only 802.11n clients are present. This is the default setting.
- **11b/g/Next Mixed Mode.** This setting yields the best overall performance when a mixture of 802.11b, 802.11g, and 802.11n clients are present.

To modify the Advanced Wireless Settings:

1. Select **Wireless Settings** under the **Advanced** menu on the left navigation pane of the user interface. The **Advanced Wireless Settings** screen will display.

Advanced Wireless Settings

Wireless LAN Parameters

WMM Support Enable Disable

RTS Threshold (1-2346)

Fragmentation Length (256-2346)

Beacon Interval (20-1000) ms

DTIM Interval (1-255)

Preamble Type Long Auto

Wireless Optimization Settings

11n Max Speed

11 b/g/n Mixed mode

Figure 4-8

2. Make the changes to the Wireless LAN Settings based on the field descriptions outlined above.
3. Click **Apply** for your changes to take effect.

Configuring the RADIUS Server Settings

RADIUS (Remote Authentication Dial In User Service) is a protocol for managing Authentication, Authorization and Accounting (AAA) of multiple users in a network. A RADIUS server stores a database of user information, and can validate a user at the request of a gateway device in the network when a user requests access to network resources. The wireless access point can relay login information from wireless clients to an external RADIUS server for AAA services. In an environment with many users, using a RADIUS server allows centralized control for individual users, providing better network security than using a single preshared key for all users.

Configure the RADIUS Server Settings menu with the parameters described in [Table 4-1](#):

Table 4-1. RADIUS Server Settings Fields

Field	Description
Primary and Secondary Authentication Servers	The Authentication RADIUS Server provides authentication and access control. The primary server is mandatory. A secondary server, which will be used if the primary server fails, is optional.
IP Address	The IP address of the authentication server. If no server is present, enter 0.0.0.0.
Port Number	The port number used for communication to the authentication server. The default port number for an authentication server is 1812.
Shared Secret	The shared secret to establish a client connection to the Radius server, as entered on the server itself.
Re-authentication Time	The time interval in seconds after which the supplicant will be authenticated again with the RADIUS Server. The default interval is 3600 seconds.
Update Global Key	Enable this option to have the Global Key changed according to the time interval specified. If enabled, enter the desired time interval. The default is enable, and the default interval is 3600 Seconds
Update if any station disassociates	Enable this option to refresh the Global Key whenever any station disassociates with the wireless access point. The default is disable.
Primary and Secondary Accounting Servers	The Accounting RADIUS Server provides accounting services. The same RADIUS server may be used for both authentication and accounting, but the port numbers for authentication and accounting must be different. The accounting servers are optional.
IP Address	The IP address of the accounting server. If no server is present, enter 0.0.0.0.
Port Number	The port number used for communication to the accounting server. The default port number for an accounting server is 1813.
Shared Secret	The shared secret to establish a client connection to the RADIUS server, as entered on the server itself.

To configure the RADIUS Server Settings:

1. Select **Radius Server Settings** under the **Security** menu on the left navigation pane of the user interface. The **Radius Server Settings** screen will display.

Radius Server Settings

Primary Authentication Server

IP Address: 0 . 0 . 0 . 0

Port Number: 1812

Shared Secret: [Empty]

Secondary Authentication Server

IP Address: 0 . 0 . 0 . 0

Port Number: 1812

Shared Secret: [Empty]

Authentication Settings

Reauthentication Time: 3600 Seconds

Update Global Key every 3600 Seconds

Update if any station disassociates

Primary Accounting Server

IP Address: 0 . 0 . 0 . 0

Port Number: 1813

Shared Secret: [Empty]

Secondary Accounting Server

IP Address: 0 . 0 . 0 . 0

Port Number: 1813

Shared Secret: [Empty]

Apply Cancel

Figure 4-9

2. Make the changes to the RADIUS Server Settings based on the field descriptions outlined above.
3. Click **Apply** for your changes to take effect.

Chapter 5

Advanced Wireless Bridging

This chapter describes how to configure the advanced features of your WN802T to one of six Access Point Modes or in Wireless Bridge and Repeater Mode. These features can be found under the Advanced heading in the main menu on the Wireless Settings Wireless Bridging screens.

The RangeMax NEXT Wireless-N Access Point lets you build large wireless networks. Examples of wireless bridging configurations are:

- **Access Point.** Standard Access Point mode (default mode). Operates as a standard 802.11b/g or 802.11b/g/n Access Point. In this mode, the WN802T will communicate only with wireless clients.
- **Wireless multi-point bridging.** Acts as the “master” and communicates with up to six bridge-mode wireless access points. All of the other wireless access points communicate through the WN802T when the WN802T is in this mode.
- **Repeater with Wireless Client Association.** Acts as a “repeater” and forwards all traffic to a remote access point.

Configuring Wireless Multi-Point Bridging

In this mode, the WN802T will communicate with up to six bridge-mode wireless access points by entering the MAC address (physical address) of each of the bridge-mode APs in the fields provided. In addition, if you check the Enable Wireless Client Association checkbox, wireless clients will also be serviced by this access point. Each wireless access point you enter will be listed in the Wireless Remote Access Point List.

To configure wireless Multi-point Bridging:

1. Open a web browser and log into the WN802T using the addressing scheme you have set up

Advanced Wireless Bridging Settings

Access Point Mode

Access Point

Wireless Multi-Point Bridging

Enable Wireless Client Association

Remote MAC Address -----

Repeater with Wireless Client Association

Remote MAC Address -----

Remote Access Point	MAC address	
1		<input type="button" value="Delete"/>
2		<input type="button" value="Delete"/>
3		<input type="button" value="Delete"/>
4		<input type="button" value="Delete"/>
5		<input type="button" value="Delete"/>
6		<input type="button" value="Delete"/>

Figure 5-1

2. Under **Advanced** on the main menu, click **Wireless Bridging**. The **Advanced Wireless Bridging** screen will display showing the default settings for the wireless access point.
3. Select the **Wireless Multi-Point Bridging** radio button to enable multi-point bridging.
4. Enter the MAC address of the first wireless access point and click **Add**. The AP's MAC address and connection information will appear in the **Wireless Accept Point List**.

You can add wireless access points to the list for a total of six. (These wireless access points must be configured for Multi-Point Bridging.)

5. Check the **Enable Wireless Client Association** radio box to allow wireless clients access to this wireless access point.
6. Click **Apply** to save your changes.

To delete a remote AP from the list, click **Delete** adjacent to the AP's MAC address in the Wireless Remote Access Point List.

The following figure illustrates a multi-point bridge setup over three LAN segments.

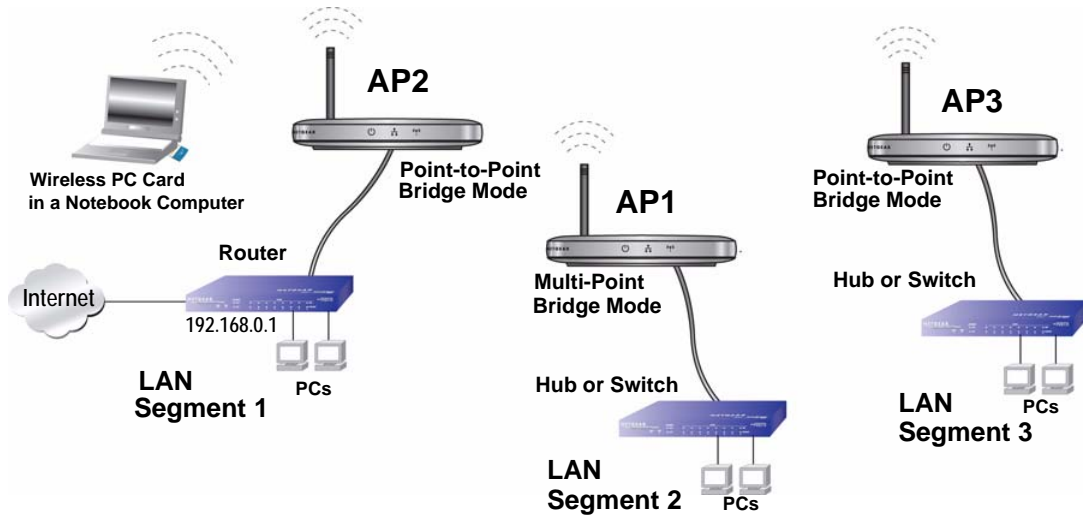

Figure 5-2

To configure wireless access points in a multi-point configuration:

1. Set the Operating Mode of the three RangeMax NEXTs as follows:
 - Configure AP2 on LAN Segment 1 in Point-to-Point Bridge Mode. Enable Wireless Client Association and add the Remote MAC Address of AP1 on LAN Segment 2.
 - Because it is in the central location, configure AP1 on LAN Segment 2 in Multi-Point Bridging mode. Enable Wireless Client Association and add the MAC addresses of the adjacent Point-to-Point APs (AP2 and AP3).
 - Configure AP3 on LAN 3 in Point-to-Point Bridge mode. Enable Wireless Client Association and add the Remote MAC Address of AP1 on LAN Segment 2.
2. Verify the following parameters for all three wireless access points:
 - That the LAN network configuration of each of the RangeMax NEXTs is configured to operate in the same LAN network address range as the other LAN devices (routers, hubs and switches).
 - That only one wireless access point is configured in Multi-Point Bridging mode, and that all the others are in Point-to-Point Bridge mode.
 - That all APs are be on the same LAN. That is, all the wireless access point LAN IP addresses are in the same network.

- If using DHCP, all wireless access points should be set to “Obtain an IP address automatically (DHCP Client)” in the IP Address Source portion of the Basic IP Settings menu.
- That all wireless access points are using the same SSID, Channel, WEP authentication mode, if any, and encryption (WPA is not available in bridge modes).
- That each Point-to-Point AP has the Multi-Point AP MAC address in its Remote AP MAC address table.
- If Access Control has been enabled on the APs, verify that the Wireless Cards table (MAC Address List) for each AP is complete and accurate.

3. Verify connectivity across the LANs.

- If you checked the Enable Wireless Client Association radio box on each AP, wireless clients will be able to use the AP.
- A computer on any LAN segment should then be able to connect to the Internet or share files and printers with any other PCs or servers connected to any of the three LAN segments.
- If Access Control Lists are enabled on the APs, only computers in the access control list will be able to use the AP.



Note: You can extend multi-point bridging by adding a total of six WN802T APs configured in Point-to-Point mode to connect additional wireless LAN segments.

Configuring Repeater with Wireless Client Association

In this mode, the WN802T will operate as a Repeater only, and send all traffic to the remote wireless access point. You must enter the MAC address (physical address) of the remote wireless access point.

To configure the WN802T in wireless repeater mode:

1. Open a web browser and log into the WN802T using the addressing scheme you have set up.

Advanced Wireless Bridging Settings

Access Point Mode

Access Point
 Wireless Multi-Point Bridging
 Enable Wireless Client Association
 Remote MAC Address -----
 Repeater with Wireless Client Association
 Remote MAC Address -----

Remote Access Point	MAC address	
1		<input type="button" value="Delete"/>
2		<input type="button" value="Delete"/>
3		<input type="button" value="Delete"/>
4		<input type="button" value="Delete"/>
5		<input type="button" value="Delete"/>
6		<input type="button" value="Delete"/>

Figure 5-3

2. Under **Advanced** on the main menu, click **Wireless Bridging**. The **Wireless Bridging** screen will display showing the default settings for the wireless access point.
3. Select the **Repeater with Wireless Client Association** radio button to enable Repeater Mode.
4. Enter the MAC address of the remote wireless access point and click **Add**. The AP's MAC address and connection information will appear in the **Wireless Remote Access Point List**.
5. Click **Apply** to save your changes.

The following drawing illustrates two wireless access points daisy-chained together in wireless repeater mode

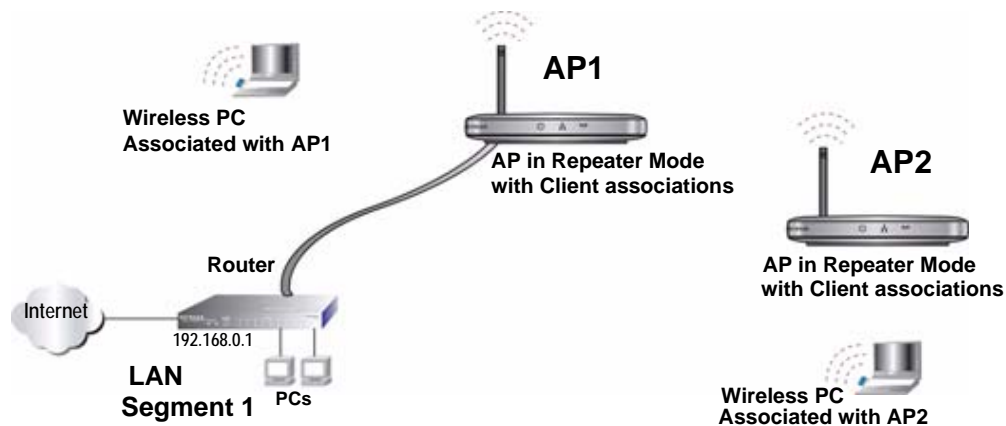

Figure 5-4

To configure a LAN segment utilizing the WN802T in Repeater Mode:

1. Configure the Operating Mode of the RangeMax NEXTs.
 - Configure AP1 on LAN Segment 1 in Repeater mode with the Remote MAC Address of the “downstream” remote AP (AP2).
 - Configure AP2 in Repeater mode with the MAC address of the “upstream” AP (AP1).
2. Verify the following parameters for all access points:
 - That the RangeMax NEXTs are configured to operate in the same LAN network address range as the LAN devices.
 - That all APs are on the same LAN. That is, all AP LAN IP addresses must be in the same network.
 - If using DHCP, that all RangeMax NEXTs should be set to “Obtain an IP address automatically (DHCP Client)” in the IP Address section of the **IP Settings** screen.
 - That all RangeMax NEXTs use the same SSID, Channel, authentication mode, if any, and encryption in use.
3. Verify connectivity across the LANs.

A computer on any LAN segment should be able to connect to the Internet or share files and printers with any other PCs or servers connected to any of the three WLAN segments.

Chapter 6

Troubleshooting

This chapter provides information for troubleshooting issues with your RangeMax NEXT Wireless-N Access Point. Following each problem description, instructions are provided to assist you in diagnosing and solving the problem.

Following are some tips for correcting simple problems that could occur.

No lights are lit on the access point.

The access point has no power.

- Make sure the power cord is connected to the access point and plugged in to a working power outlet or power strip.
- Make sure you are using the correct NETGEAR power adapter supplied with your access point; in this case the Switching Power Supply.

The Ethernet light is not lit.

There is a hardware connection problem.

- Make sure the cable connectors are securely plugged in at the wireless access point and the network device (hub, switch, or router).
- Make sure the connected device is turned on.

The WLAN light is not lit.

The wireless access point build-it antennas are not functioning properly.

- Check the “Turn Radio On” radio button setting on the **Wireless Settings** screen under the **Setup** menu. It must be turned on (checked).

- If the Wireless LAN activity light stays off, disconnect the adapter from its power source and then plug it in again.
- Contact NETGEAR if the WLAN light remains off.

I cannot configure the access point from a browser.

Check these items:

- The WN802T is properly installed, LAN connections are OK, and it is powered on. Check that the LAN port LED is blinking green to verify that the Ethernet connection is OK.
- If you are using the NetBIOS name of the WN802T to connect (DHCP Client is enabled), ensure that your PC and the WN802T are on the same network segment or that there is a WINS server on your network. Using the default NetBIOS name: **netgearxxxxxx**, where **xxxxxx** is the last 6 digits of the wireless access point MAC address; or, if you have modified the name, make sure you have input it correctly. (The name may be up to 15 characters long.)
- If DHCP is not enabled, make sure you are using the correct LAN IP Address to access the wireless access point, and that you are on the same network segment.
- If DHCP is enabled, and you cannot connect using the default NetBIOS name, configure your DHCP server (either built into the router or a separate server) with a reserve IP (based on the wireless access point's MAC address). You can then use it to create a fixed IP for the wireless access point.
- If you have not yet deployed the wireless access point, and it is connected to your PC via an Ethernet cable, make sure the connection is secure, and that you have configured your PC with a static IP in the same subnet as the LAN IP of wireless access point. The default static IP address to use for your PC is 192.168.0.210; the default wireless access point LAN IP is 192.168.0.233; and the default Subnet Mask is 255.255.255.0.

I cannot access the Internet or the LAN with a wireless capable computer.

There is a configuration problem. Check these items:

- You may not have restarted the computer with the wireless adapter to have TCP/IP changes take effect. Restart the computer.

- The computer with the wireless adapter may not have the correct TCP/IP settings to communicate with the network. Restart the computer and check that TCP/IP is set up properly for that network. The usual setting for Windows on the Network Properties is set to “Obtain an IP address automatically.”
- The wireless access point’s default values may not work with your network. Check the wireless access point’s default configuration against the configuration of other devices in your network.
- For full instructions on changing the wireless access point’s default values, see [Chapter 2, “Installation and Configuration”](#) and [Chapter 3, “Wireless Security Settings”](#).

When I enter a URL or IP address I get a timeout error.

A number of things could be causing this. Try the following troubleshooting steps.

- Check whether other computers work. If they do, ensure that your computer’s IP Address, Subnet Mask and Default Gateway settings are correct. If using a DNS Server, check the Primary and Secondary DNS Server Addresses.
- If the computers are configured correctly, but still not working, ensure that the WN802T is connected and turned on. Connect to it and check its settings. If you cannot connect to it, check the LAN and power connections.
- If the WN802T is configured correctly, check your Internet connection (DSL/Cable modem, etc.) to make sure that it is working.
- Try again.
- When entering configuration settings, be sure to click the **Apply** button before moving to another menu or tab, or your changes are lost.
- Click the Refresh or Reload button in the Web browser. The changes may have occurred, but the Web browser may be caching the old configuration.

Using the Reset Button to Restore Factory Default Settings

The reset button on the rear panel of the WN802T has two functions:

- **Reboot:** When pressed and released quickly, the WN802T will reboot (restart).

- **Reset to Factory Defaults:** This button can also be used to clear ALL data and restore ALL settings to the factory default values. These settings are shown in [Appendix A, “Default Settings and Technical Specifications”](#).

To clear all data and restore the factory default values:

1. Power off the WN802T and power it back on.
2. Use something with a small point, such as a pen, to press the reset button in and hold it in for at least five seconds—or until the power light changes from blinking green to amber.
3. Release the reset button.

The factory default configuration has now been restored, and the WN802T is ready for use.

Appendix A

Default Settings and Technical Specifications

This appendix provides the factory default settings and technical specifications for the RangeMax NEXT Wireless-N Access Point.

Factory Default Settings

You can use the reset button located on the front of your device to reset all settings to their factory defaults. This is called a hard reset.

- To perform a hard reset, push and hold the reset button for approximately 5 seconds (until the Power LED changes from blinking green to solid amber). Your device will return to the factory configuration settings shown in [Table A-1](#) below.
- Pressing the reset button for a shorter period of time will simply cause your device to reboot.

Table A-1. Access Point Default Configuration Settings

Feature	Description
AP Login	
User Login URL	192.168.0.233 or netgearxxxxxx"; where xxxxxx is the last 6 hexadecimal digits of the WN802T MAC address.
User Name (case sensitive)	admin
Login Password (case sensitive)	password
Ethernet Connection	
Access Point Name	netgearxxxxxx where xxxxxx are the last 6 digits of the wireless access point MAC address.
Ethernet MAC Address	See rear label.
Access Point Mode	On
Port Speed	10/100/1000 Mbps
Local Network (LAN)	

Table A-1. Access Point Default Configuration Settings

Feature		Description
	Lan IP	192.168.0.233
	Subnet Mask	255.255.255.0
	Gateway Address	192.168.0.1
	DHCP Client	Disabled
	Time Zone	GMT-08:00
	Time Zone Adjusted for Daylight Saving Time	Disabled
Wireless		
	Operating Mode	11b/g/Next (20/40 MHz)
	Wireless Communication	Enabled
	Wireless Network Name (SSID)	NETGEAR
	Broadcast Network Name SSID	Enabled
	Security	Disabled
	Transmission Speed	Auto ^a
	Country/Region	United States (in North America; otherwise, varies by region)
	Channel/Radio Frequency	6/2.43 GHz (until the region is selected)
	Output Power	Full
	Wireless Card Access List	All wireless stations allowed

a. Maximum Wireless signal rate derived from IEEE Standard 802.11 specifications. Actual throughput will vary. Network conditions and environmental factors, including volume of network traffic, building materials and construction, and network overhead, lower actual data throughput rate.

Technical Specifications

Table A-2. WN802T Technical Specifications

Parameter	RangeMax NEXT Wireless-N Access Point
802.11Next Data Rates	7.2, 14.4, 21.7, 28.9, 43.3, 57.8, 65, 72.2, 87.7, 115.6, 130 & 144.4 Mbps (20Hz) 15, 30, 45, 60, 90, 120, 135, 150, 180, 240, 270 & 300 Mbps (40Hz)
802.11b/g Data Rates	1, 2, 5.5, 11, 12, 18, 24, 36, 38, 54, & 108 Mbps (Auto-rate capable)
802.11b/g/Next Operating Frequencies	2.412 ~ 2.462 GHz (US) 2.457 ~ 2.462 GHz (Spain) 2.412 ~ 2.484 GHz (Japan) 2.457 ~ 2.472 GHz (France) 2.412 ~ 2.472 GHz (Europe ETSI)
802.11b/g/Next Encryption	40-bits (also called 64-bits), 128-bits WEP data encryption; TKIP (WPA-PSK) and AES (WPA2-PSK)
Network Management	Web-based configuration and status monitoring
Maximum Clients	Limited by the amount of wireless network traffic generated by each node; typically 15 to 20 nodes.
Status LEDs	Power/Ethernet LAN/Wireless LAN
Power Adapter	12V DC, 1.5 A Switching Power Supply
Electromagnetic Compliance	FCC Part 15 Class B and Class E, CE, and C-TICK
Environmental Specifications	Operating temperature: 0 to 50° C Operating humidity: 5-95%, non-condensing

Appendix B

Related Documents

This appendix provides links to reference documents you can use to gain a more complete understanding of the technologies used in your NETGEAR product.

Document	Link
Internet Networking and TCP/IP Addressing	http://documentation.netgear.com/reference/enu/tcpip/index.htm
Wireless Communications	http://documentation.netgear.com/reference/enu/wireless/index.htm
Preparing a Computer for Network Access	http://documentation.netgear.com/reference/enu/wsdhcp/index.htm
Virtual Private Networking (VPN)	http://documentation.netgear.com/reference/enu/vpn/index.htm
Glossary	http://documentation.netgear.com/reference/enu/glossary/index.htm

Numerics

- 11b/g/Next 4-8
 - default mode 2-9
- 11n 4-8
- 11Next 4-8
- 128-bit data encryption 3-5
- 192.168.0.210
 - static IP, default 6-2
- 192.168.0.210, Static IP Address 2-3
- 192.168.0.230, default address 2-3
- 192.168.0.233
 - LAN IP, default 6-2
- 255.255.255.0
 - default subnet 2-3
 - subnet mask, default 6-2
- 64-bit data encryption 3-5
- 802.11b 4-8
- 802.11g 4-8
- 802.11n 4-8

A

- AAA (Authentication, Authorization and Accounting) 4-9
- Access Control
 - configuring 3-10
- Access Control List 3-10, 3-11
- Access Point mode 5-1
- Access Point name, default 2-6
- Advanced Wireless Settings
 - modifying 4-8
- Authentication Type
 - WEP 3-5
- Available Wireless Cards 3-11
- Available Wireless Station List 4-5

B

- Backup/Restore Settings 4-3
- Basic Settings menu 2-5
- brackets
 - installing 2-10
 - wall mount 2-10
- Broadcast SSID 2-8
- Broadcast Wireless Network Name 2-8

C

- Change Password 4-1
- Channel/Frequency 2-9
- channel/frequency
 - default Australia 2-9
 - default Canada 2-9
 - default Europe 2-9
 - default US 2-9
- configuration
 - restore 4-7
- configure the RangeMax NEXT 2-3
- Country/Region 2-8

D

- Data Encryption 3-3
 - Automatic 3-5
 - Manual 3-5
- Data Rate 2-9
- Daylight Saving Time
 - adjustment for 2-7
- default login 2-3
- default password 2-3, 2-13, 4-1
- Default Settings A-1
- default settings 2-9

default SSID 2-8
default subnet mask
 255.255.255.0 2-3
default user name 2-3, 2-13
DHCP Client 2-6
 enabling 2-6
dynamic IP addresses
 enabling 2-7

E

Enable Wireless Client Association 5-2
Encryption Strength
 WEP 3-5
equipment placement
 reception range 2-1

F

Flash memory, for firmware upgrade 1-2
Fragmentation Length 4-8

G

Gateway
 default address 2-7

H

http
 //192.168.0.230 2-12

I

interference sources 2-2
IP Address
 default 2-6, 2-12
IP address
 default 2-6, 2-12
 reserving 2-12
IP Subnet Mask
 default 2-6
IP Subnet mask
 default 2-6

L

LAN IP
 default 6-2
LAN IP address
 default 3-10
login screen 2-13

M

MAC Address 3-11
MAC address 2-6, 2-12, 3-10, 6-2
 restricting access 3-1
 trusted PCs 3-1
 Trusted Wireless Stations 3-10
Mixed Mode 4-8
multiple access points
 placement of 2-2
Multi-Point Bridging
 about 5-1
 example of 5-3
 extending 5-4
Multi-point Bridging
 configuration of 5-1
Multi-point bridging 5-1

N

NetBIOS 2-6
 login name 6-2
NetBIOS name
 default 6-2
 logging in 2-12
NETGEAR
 default SSID 2-8
Network Authentication 3-2
 types of 3-2
New Password 4-2

O

Old Password 4-2
Open System 3-3

P

package contents 1-3

Passphrase

- use with WEP 3-3

- used with WPA2-PSK 3-3

- used with WPA-PSK 3-3

- used with WPA-PSK=WPA2-PSK 3-3

passphrase

- use with WEP 3-5

password

- changing default 4-1

- default 2-9, 2-13, 3-10

performance degradation

- causes of 2-2

Primary DNS Servers

- default 2-7

Q

QoS 4-7

Quality of Service 4-7

R

radio frequency

- recommended channels 2-2

- spacing between APs 2-2

Radius

- configuring server settings 4-10

- defined 4-9

- selecting 3-8

- with WPA and WPA2 3-2

RADIUS Server Settings

- configuring 4-10

- field descriptions 4-10

Range 2-1

RangeMax Next

- configuring 2-3

Reboot AP 4-5

rebooting 4-5

reception range

- equipment placement 2-1

Repeater with Wireless Client Association 5-1, 5-4, 5-5

- configuration of 5-5

- example 5-6

Reserve IP

- configuring 6-2

Reserve IP Address 2-12

Reset Button

- reboot 6-3

- restore defaults 6-3

restore configuration 4-7

Restore Default Password 4-2

Restore Saved Settings from a File 4-4

restricting access

- MAC address, using 3-10

RTS Threshold 4-7

S

Secondary DNS Servers

- default 2-7

security

- network enhancements 3-1

- WPA 3-2

- WPA-PSK 3-2

security options

- WEP data encryption 3-1

- WPA-PSK 3-1

Settings

- Backup 4-3

- Restore 4-3

- Retrieving 4-4

- Saving a copy of 4-4

settings

- restoring from a file 4-4

Shared Key 3-3

SSID 2-8, 2-11

- disabling, consequences of 3-1

static IP

- default 6-2

Static IP Address, 192.168.0.210 2-3

Statistics 4-6

statistics

- Wired Ethernet 4-7

Wireless 4-7
subnet mask default 6-2
system requirements 2-2

T

TCP/IP
troubleshooting 6-2
Technical Specifications A-3
Time Zone 2-7
TKIP 3-7
troubleshooting 6-1
Trusted Wireless Stations 3-10, 3-11, 3-12
trusted wireless stations
configuring 3-11
Turn Access Control On 3-10
configuring 3-10
Turn Radio On 2-8

U

Upgrade Firmware 4-2
upgrading firmware 4-2
Uploading firmware 4-3
user name
default 2-9, 2-13, 3-10

W

WEP 3-1
Authentication Type 3-5
WEP Authentication 3-3
WEP/WPA Settings 3-7, 3-8
Wi-Fi Multimedia 4-7
Wired Ethernet
statistics 4-7
Wireless 2-7
statistics 4-7
Wireless Accept Point List 5-2
wireless access point
deployment of 2-10
Wireless Bridging 5-2, 5-5

Wireless Card Access Setup 3-11
wireless configuring
802.11b/g modes 2-3, 2-7
802.11b/g/Next mode 2-3, 2-7
wireless connectivity
testing 2-9
Wireless Mode 2-8
wireless mode
default 2-9
Wireless Multi-Point Bridging 5-2
Wireless Network Name 2-8
Wireless Optimization Settings 4-8
Wireless Remote Access Point List 5-5
Wireless Repeater 5-4
configuration of 5-5
example 5-6
wireless security
options 3-1
Wireless Setting
modifying advanced settings 4-8
Wireless Settings 2-7
advanced 4-7
wireless settings
configuring 802.11b/g/Next 2-7
screen 2-7
WMM 4-7
WMM Support 4-7
WN802T
default password 4-1
WPA 3-2
use restrictions 3-2
WPA + WPA2 with Radius 3-9
WPA with Radius 3-9
WPA2
use restrictions 3-2
WPA2 with Radius 3-9
WPA2-PSK 3-7
WPA-PSK 3-2
configuration of 3-7, 3-8
Network Authentication screens 3-7
restrictions 3-7, 3-8

[TKIP 3-7](#)

[WPA-PSK + WPA2-PSK 3-7](#)

